



COLLARI **SERIE SPECIALE**

SERIE SPECIALE
COLLARI

67

MATERIALI STANDARD DEL CORPO COLLARE



Polipropilene
Colore **Blu**
Codice PP

**ALTRI COLORI
DISPONIBILI A RICHIESTA!**



Poliammide
Colore **Nero**
Codice PA



Gomma Elastomero
Colore **Nero**
Codice GM



Polipropilene Autoestinguente
Colore **Bianco**
Codice AU

DIVERSI DIAMETRI E MATERIALI DISPONIBILI A RICHIESTA.

Superficie interna corpo collare:
con scanalature

Per le caratteristiche dei Materiali vedi l'Appendice Tecnica
(pag. 143)

MATERIALI STANDARD DI COMPONENTI E ACCESSORI

Acciaio S 235 JR con trattamento superficiale in zincatura bianca
Fe Zn c8 II.

Grezzi sono disponibili a richiesta.

Acciaio Inox Inox 316L (X2 CrNiMo 17-12-2) 1.4404
contraddistinti dal codice X.

Filettatura Metrica: codice M

Filettatura UNC: codice UNC.

Per le caratteristiche dei Materiali vedi l'Appendice Tecnica
(pag. 143)





S CORPO COLLARE

COPPIA DI SEMICOLLARI

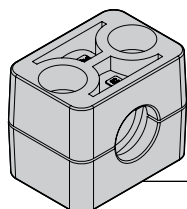

TIPO 2

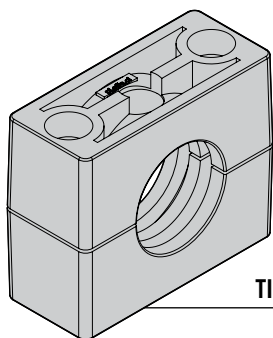

TIPO 3

| Codice | D.E. ØD1 | | L1 | L2 | L3 | H | S | Larghezza |
|--------|----------|-------------|---------------|---------------|---------------|---------------|---------------|---------------|
| | mm | Pollici gas | | | | | | |
| | 8 | | | | | | | |
| | 10 | 1/8" | | | | | | |
| | 12 | | | | | | | |
| | 14 | | | | | | | |
| S2 | 15 | | 43 (1.69") | 26 (1.02") | ... | 33 (1.30") | 0,8 (.04") | 30 (1.18") |
| | 16 | | | | | | | |
| | 17,2 | 3/8" | | | | | | |
| | 18 | | | | | | | |
| | 20 | | | | | | | |
| | 21,3 | 1/2" | | | | | | |
| | 22 | | | | | | | |
| | 23 | | | | | | | |
| | 25 | | | | | | | |
| | 26,9 | 3/4" | | | | | | |
| S3 | 28 | | 70 (2.75") | 52 (2.05") | 26 (1.02") | 57 (2.24") | 1 (.04") | 30 (1.18") |
| | 30 | | | | | | | |
| | 32 | | | | | | | |
| | 33,7 | 1" | | | | | | |
| | 35 | | | | | | | |
| | 38 | | | | | | | |
| | 40 | | | | | | | |
| | 42,4 | 1.1/4" | | | | | | |

COLLARI
SERIE SPECIALE

68

Codice S (Materiale PP - PA - GM - AU)

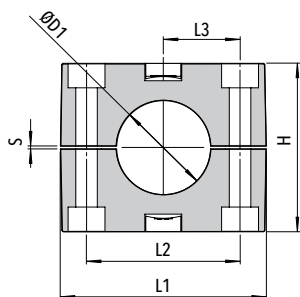
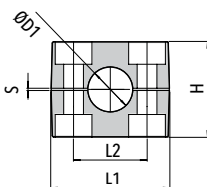

CODICE ORDINAZIONE

| CODICE CORPO-COLLARE | DIAMETRO ESTERNO (mm) | MATERIALE |
|----------------------|-----------------------|-----------|
|----------------------|-----------------------|-----------|

ESEMPIO

Tipo corpo collare: 2
Materiale: PP
Diametro esterno: 15 mm
Codice ordinazione: S2 - 15 - PP



PP PIASTRA A SALDARE SINGOLA

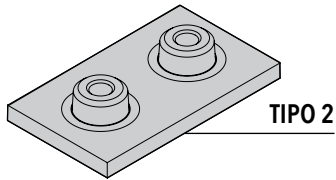
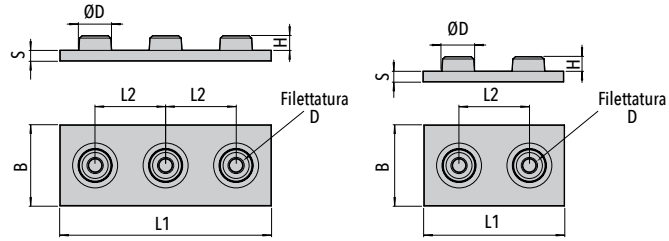

TIPO 2

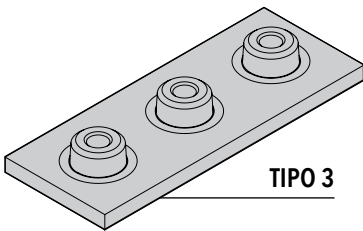

TIPO 3

| Codice | L1 | L2 | B | S | H | ØD | Filettatura D |
|--------|----|----|---|---|---|----|---------------|
|--------|----|----|---|---|---|----|---------------|

| | | | | | | | |
|---------------------------|---------------|---------------|---------------|-------------|---------------|--------------|--------------------|
| PP2 XPP2 | 52 (2.05") | 26 (1.02") | 30 (1.18") | 4 (.16") | 5,5 (.22") | 12 (.47") | M6 (1/4-20 UNC) |
|---------------------------|---------------|---------------|---------------|-------------|---------------|--------------|--------------------|

| | | | | | | | |
|---------------------------|---------------|---------------|---------------|-------------|---------------|--------------|--------------------|
| PP3 XPP3 | 78 (3.07") | 26 (1.02") | 30 (1.18") | 4 (.16") | 5,5 (.22") | 12 (.47") | M6 (1/4-20 UNC) |
|---------------------------|---------------|---------------|---------------|-------------|---------------|--------------|--------------------|

Codice **PP** (Acciaio S 235 JR)
Codice **XPP** (Acciaio Inox AISI 316L).

COLLARI
SERIE SPECIALE

PA PIASTRA A SALDARE ANGOLARE SINGOLA

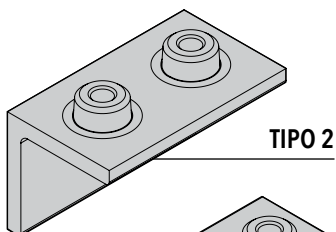
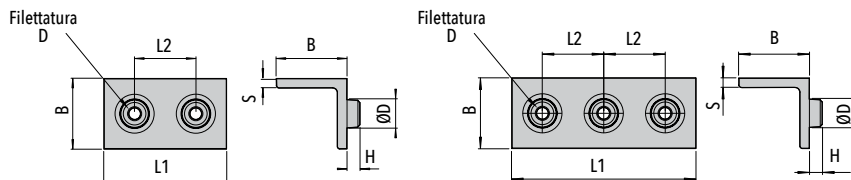

TIPO 2

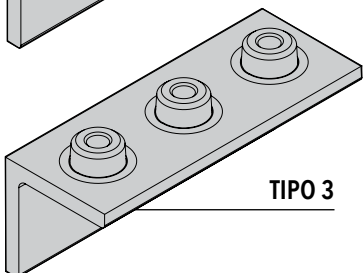

TIPO 3

| Codice | L1 | L2 | B | S | H | ØD | Filettatura D |
|--------|----|----|---|---|---|----|---------------|
|--------|----|----|---|---|---|----|---------------|

| | | | | | | | |
|---------------------------|---------------|---------------|---------------|-------------|---------------|--------------|--------------------|
| PA2 XPA2 | 52 (2.05") | 26 (1.02") | 30 (1.18") | 4 (.16") | 5,5 (.22") | 12 (.47") | M6 (1/4-20 UNC) |
|---------------------------|---------------|---------------|---------------|-------------|---------------|--------------|--------------------|

| | | | | | | | |
|---------------------------|---------------|---------------|---------------|-------------|---------------|--------------|--------------------|
| PA3 XPA3 | 78 (3.07") | 26 (1.02") | 30 (1.18") | 4 (.16") | 5,5 (.22") | 12 (.47") | M6 (1/4-20 UNC) |
|---------------------------|---------------|---------------|---------------|-------------|---------------|--------------|--------------------|

Codice **PA** (Acciaio S 235 JR)
Codice **XPA** (Acciaio Inox AISI 316L).



PPM PIASTRA A SALDARE MULTIPLA

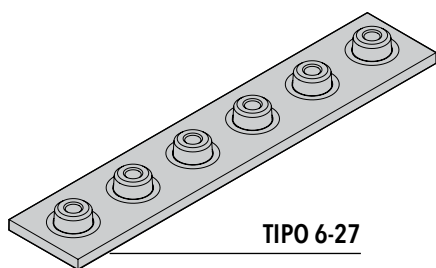
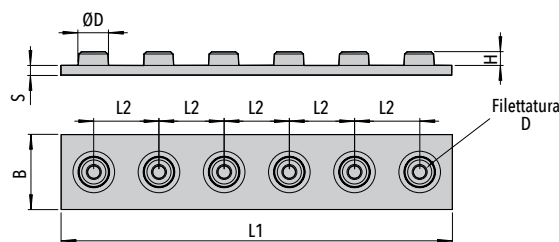

TIPO 6-27

Codice PPM (Acciaio S 235 JR)
Codice XPPM (Acciaio Inox AISI 316L).

| Codice | L1 | L2 | B | S | H | ØD | Filettatura D |
|-----------------|-----------------|---------------|---------------|-------------|-------------|--------------|--------------------|
| PPM5 XPPM5 | 130 (5.12") | 26 (1.02") | 30 (1.18") | 4 (.16") | 6 (.23") | 12 (.47") | M6 (1/4-20 UNC) |
| PPM6 XPPM6 | 156 (6.14") | 26 (1.02") | 30 (1.18") | 4 (.16") | 6 (.23") | 12 (.47") | M6 (1/4-20 UNC) |
| PPM7 XPPM7 | 182 (7.17") | 26 (1.02") | 30 (1.18") | 4 (.16") | 6 (.23") | 12 (.47") | M6 (1/4-20 UNC) |
| PPM9 XPPM9 | 234 (9.21") | 26 (1.02") | 30 (1.18") | 4 (.16") | 6 (.23") | 12 (.47") | M6 (1/4-20 UNC) |
| PPM12 XPPM12 | 312 (12.28") | 26 (1.02") | 30 (1.18") | 4 (.16") | 6 (.23") | 12 (.47") | M6 (1/4-20 UNC) |
| PPM15 XPPM15 | 390 (15.35") | 26 (1.02") | 30 (1.18") | 4 (.16") | 6 (.23") | 12 (.47") | M6 (1/4-20 UNC) |
| PPM20 XPPM20 | 520 (20.47") | 26 (1.02") | 30 (1.18") | 4 (.16") | 6 (.23") | 12 (.47") | M6 (1/4-20 UNC) |
| PPM27 XPPM27 | 702 (27.63") | 26 (1.02") | 30 (1.18") | 4 (.16") | 6 (.23") | 12 (.47") | M6 (1/4-20 UNC) |

70

PAM PIASTRA A SALDARE ANGOLARE MULTIPLA

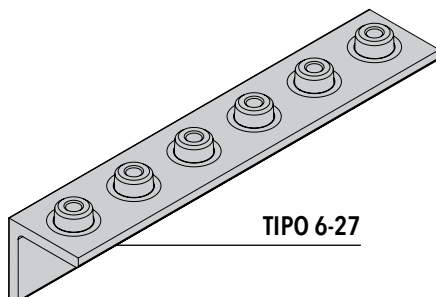
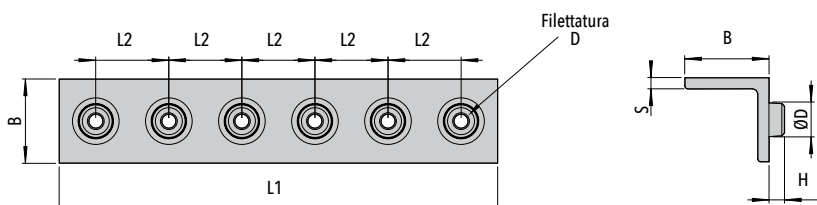

TIPO 6-27

Codice PAM (Acciaio S 235 JR)
Codice XPAM (Acciaio Inox AISI 316L).

| Codice | L1 | L2 | B | S | H | ØD | Filettatura D |
|-----------------|-----------------|---------------|---------------|-------------|-------------|--------------|--------------------|
| PAM5 XPAM5 | 130 (5.12") | 26 (1.02") | 30 (1.18") | 4 (.16") | 6 (.23") | 12 (.47") | M6 (1/4-20 UNC) |
| PAM6 XPAM6 | 156 (6.14") | 26 (1.02") | 30 (1.18") | 4 (.16") | 6 (.23") | 12 (.47") | M6 (1/4-20 UNC) |
| PAM7 XPAM7 | 182 (7.17") | 26 (1.02") | 30 (1.18") | 4 (.16") | 6 (.23") | 12 (.47") | M6 (1/4-20 UNC) |
| PAM9 XPAM9 | 234 (9.21") | 26 (1.02") | 30 (1.18") | 4 (.16") | 6 (.23") | 12 (.47") | M6 (1/4-20 UNC) |
| PAM12 XPAM12 | 312 (12.28") | 26 (1.02") | 30 (1.18") | 4 (.16") | 6 (.23") | 12 (.47") | M6 (1/4-20 UNC) |
| PAM15 XPAM15 | 390 (15.35") | 26 (1.02") | 30 (1.18") | 4 (.16") | 6 (.23") | 12 (.47") | M6 (1/4-20 UNC) |
| PAM20 XPAM20 | 520 (20.47") | 26 (1.02") | 30 (1.18") | 4 (.16") | 6 (.23") | 12 (.47") | M6 (1/4-20 UNC) |
| PAM27 XPAM27 | 702 (27.63") | 26 (1.02") | 30 (1.18") | 4 (.16") | 6 (.23") | 12 (.47") | M6 (1/4-20 UNC) |



COLLARI **SERIE SPECIALE**
Dimensioni e Codici Ordinazione (mm/in)

PS PIASTRA SUPERIORE

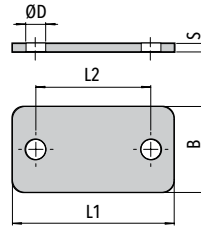

| Codice | L1 | L2 | B | S | ØD |
|--------|----|----|---|---|----|
|--------|----|----|---|---|----|

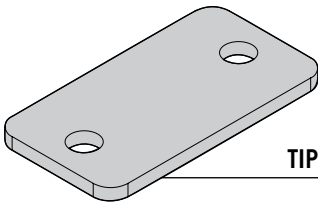

TIPO 3,6

| | | | | | |
|---------------------------|-----------------|---------------|---------------|-------------|-------------|
| PS3 XPS3 | 40,5 (1.59") | 26 (1.02") | 30 (1.18") | 3 (.12") | 7 (.28") |
|---------------------------|-----------------|---------------|---------------|-------------|-------------|

| | | | | | |
|---------------------------|-----------------|---------------|---------------|-------------|-------------|
| PS6 XPS6 | 69,5 (2.74") | 52 (2.05") | 30 (1.18") | 3 (.12") | 7 (.28") |
|---------------------------|-----------------|---------------|---------------|-------------|-------------|

Codice PS (Acciaio S 235 JR)
Codice XPS (Acciaio Inox AISI 316L)

COLLARI
SERIE SPECIALE

VE VITE A TESTA ESAGONALE

ISO 4014 / 4017
DA UTILIZZARE CON PIASTRA
SUPERIORE PS

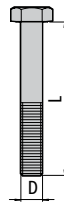

| Codice | Filettatura (D x L) |
|--------|------------------------|
|--------|------------------------|

| | |
|---------------------------|------------------------------|
| VE3 XVE3 | M6x35 (1/4-20 UNCx1.3/8") |
|---------------------------|------------------------------|

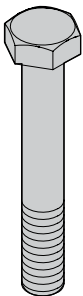

| | |
|---------------------------|------------------------------|
| VE6 XVE6 | M6x60 (1/4-20 UNCx2.3/8") |
|---------------------------|------------------------------|

Codice VE (Acciaio 8.8)
Codice XVE (Acciaio Inox A4)

TCEI VITE A TESTA CILINDRICA CON ESAGONO INCASSATO

ISO 4762

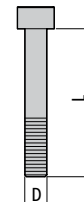

| Codice | Filettatura (D x L) |
|--------|------------------------|
|--------|------------------------|

| | |
|-------------------------------|--------------------------|
| TCEI3 XTCEI3 | M6x25 (1/4-20 UNCx1") |
|-------------------------------|--------------------------|

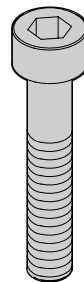

| | |
|-------------------------------|--------------------------|
| TCEI6 XTCEI6 | M6x50 (1/4-20 UNCx2") |
|-------------------------------|--------------------------|

Codice TCEI (Acciaio 8.8)
Codice XTCEI (Acciaio Inox AISI 316L)



RP RONDELLA PIANA

DA UTILIZZARE CON VITE TCEI

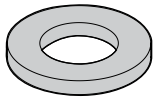
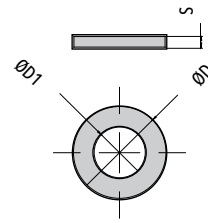

| Code | ØD | ØD1 | S |
|-----------|----------------|---------------|---------------|
| RP XRP | 11,5 (.45") | 6,3 (.25") | 0,8 (.03") |

Codice RP (Acciaio S 235 JR)

Codice XRP (Acciaio Inox AISI 316L)



ESEMPIO DI ORDINAZIONE 01

Esempio d'ordinazione collare completo S2 in Polipropilene per tubo con diametro esterno 18 mm con piastra a saldare piatta singola.

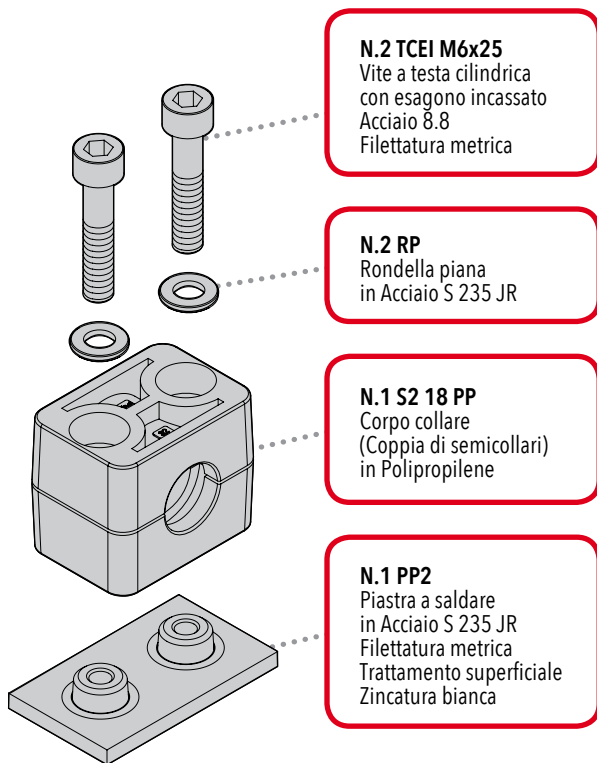

N.2 TCEI M6x25
Vite a testa cilindrica con esagono incassato Acciaio 8.8 Filettatura metrica

N.2 RP
Rondella piana in Acciaio S 235 JR

N.1 S2 18 PP
Corpo collare (Coppia di semicollari) in Polipropilene

N.1 PP2
Piastra a saldare in Acciaio S 235 JR Filettatura metrica Trattamento superficiale Zincatura bianca

ESEMPIO DI ORDINAZIONE 02

Esempio d'ordinazione collare completo S3 in Poliammide per tubo con diametro esterno 30 mm con piastra angolare singola e piastra superiore metrica.

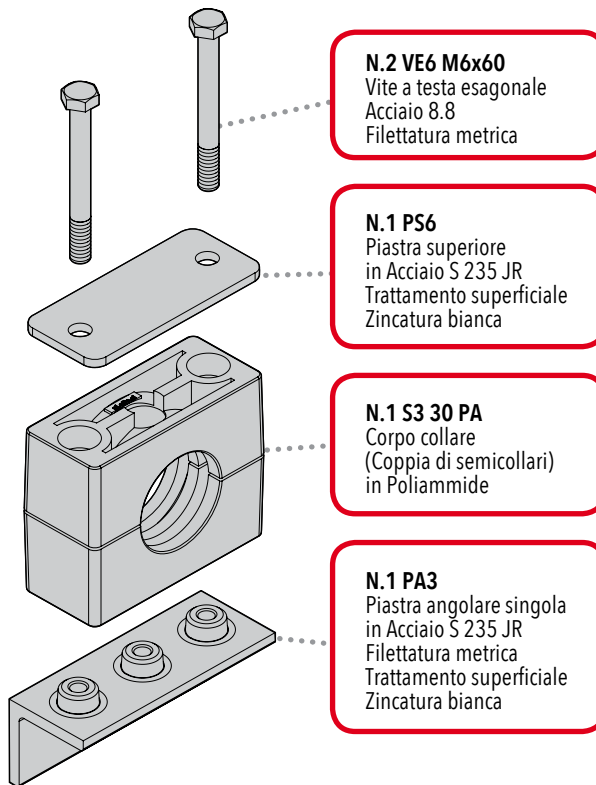

N.2 VE6 M6x60
Vite a testa esagonale Acciaio 8.8 Filettatura metrica

N.1 PS6
Piastra superiore in Acciaio S 235 JR Trattamento superficiale Zincatura bianca

N.1 S3 30 PA
Corpo collare (Coppia di semicollari) in Poliammide

N.1 PA3
Piastra angolare singola in Acciaio S 235 JR Filettatura metrica Trattamento superficiale Zincatura bianca

MOUNTING EXAMPLE 03

Esempio d'ordinazione collare completo S2 in Polipropilene per tubo con diametro esterno 18 mm e S3 in Polipropilene per tubo con diametro esterno 30 mm con piastra angolare multipla.

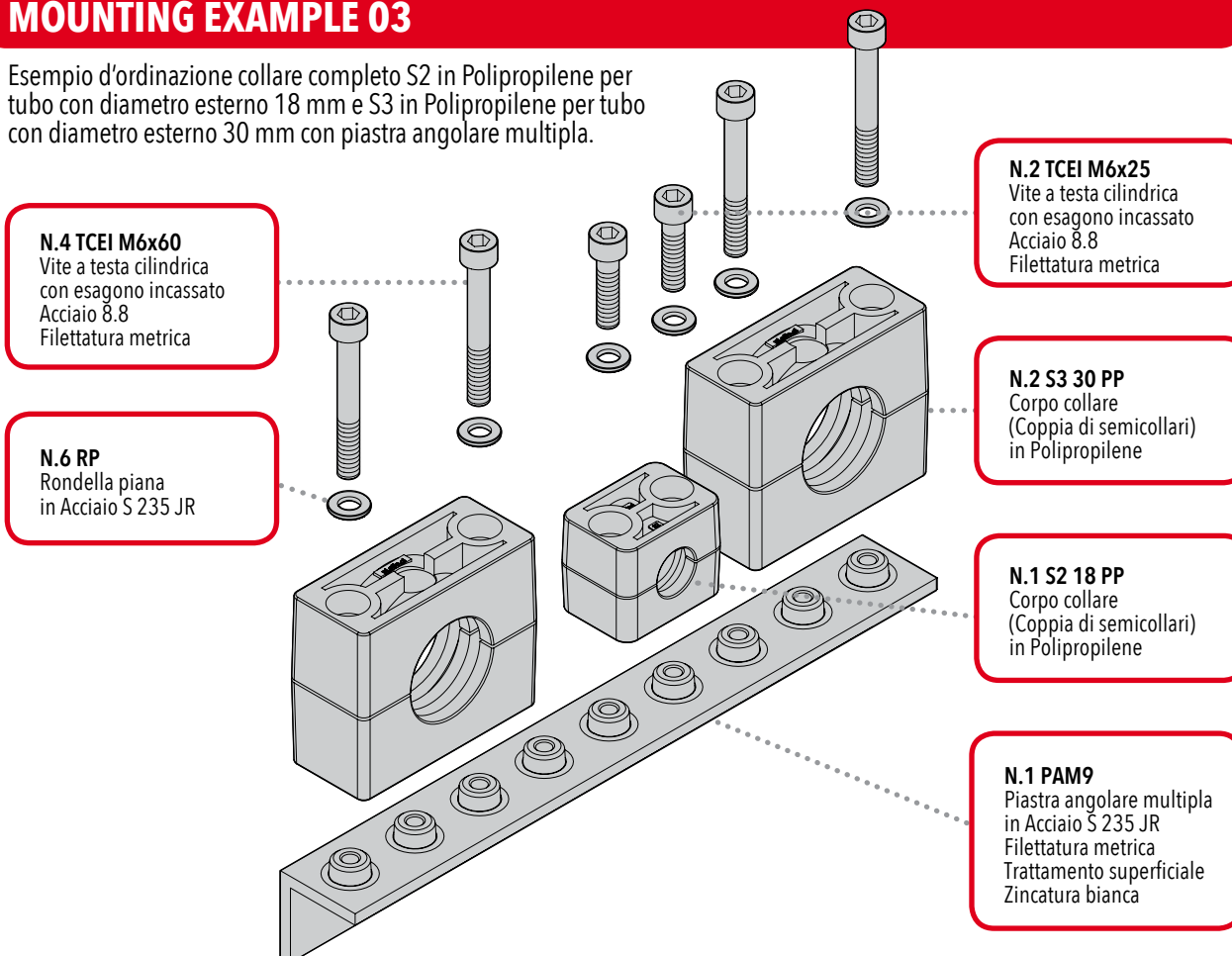

N.4 TCEI M6x60
Vite a testa cilindrica con esagono incassato Acciaio 8.8 Filettatura metrica

N.6 RP
Rondella piana in Acciaio S 235 JR

N.2 TCEI M6x25
Vite a testa cilindrica con esagono incassato Acciaio 8.8 Filettatura metrica

N.2 S3 30 PP
Corpo collare (Coppia di semicollari) in Polipropilene

N.1 S2 18 PP
Corpo collare (Coppia di semicollari) in Polipropilene

N.1 PAM9
Piastra angolare multipla in Acciaio S 235 JR Filettatura metrica Trattamento superficiale Zincatura bianca